

## MD 3200

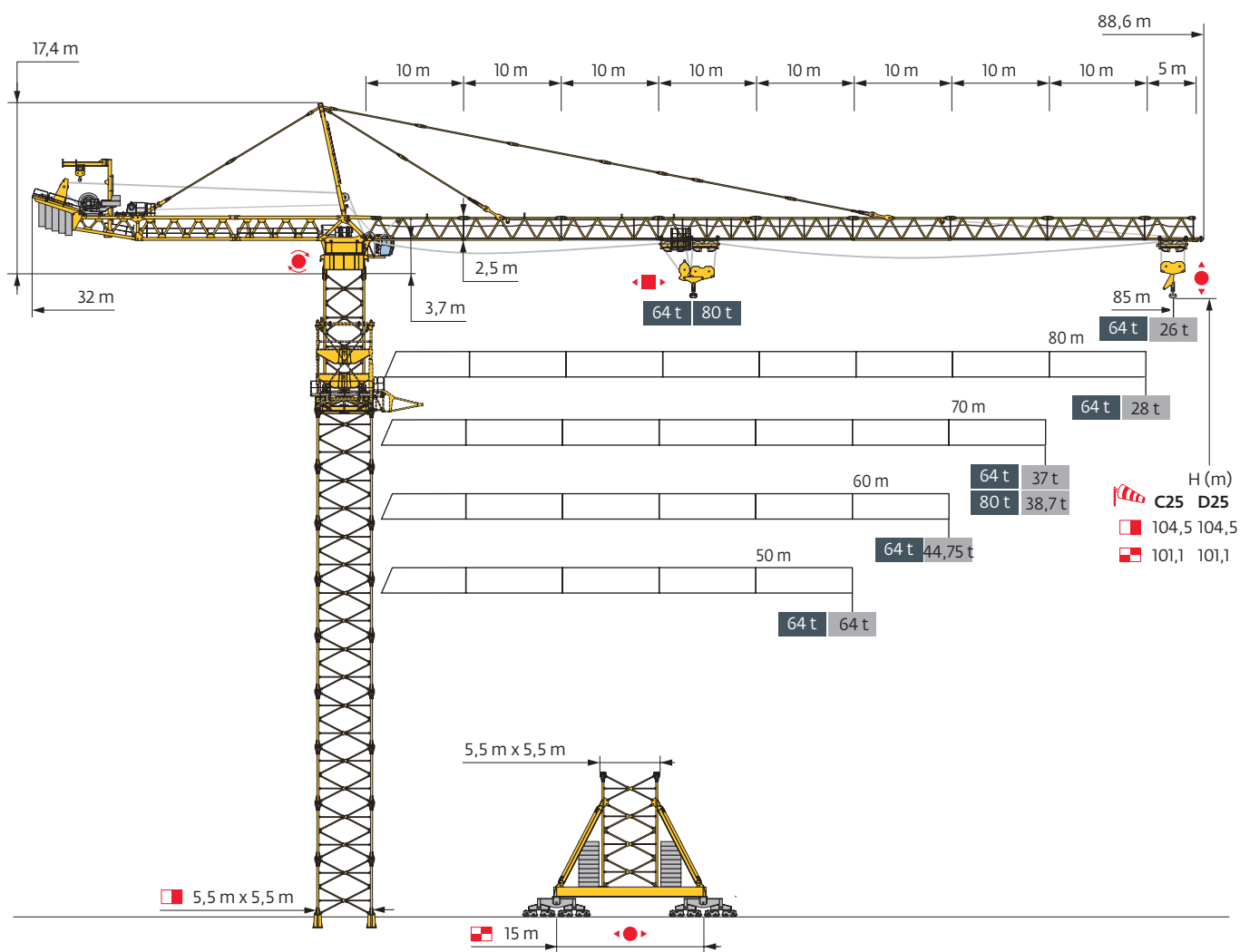

Mât - Réactions / Mast - Reaktionskräfte / Mast - Reactions / Mástil - Reacciones / Torre - Reazioni  
 Tramo - Reações / Реакция опор мачты

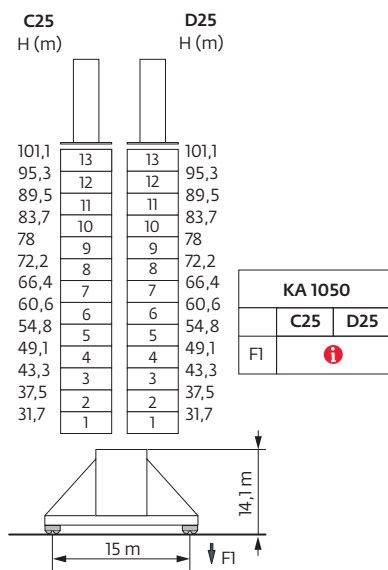
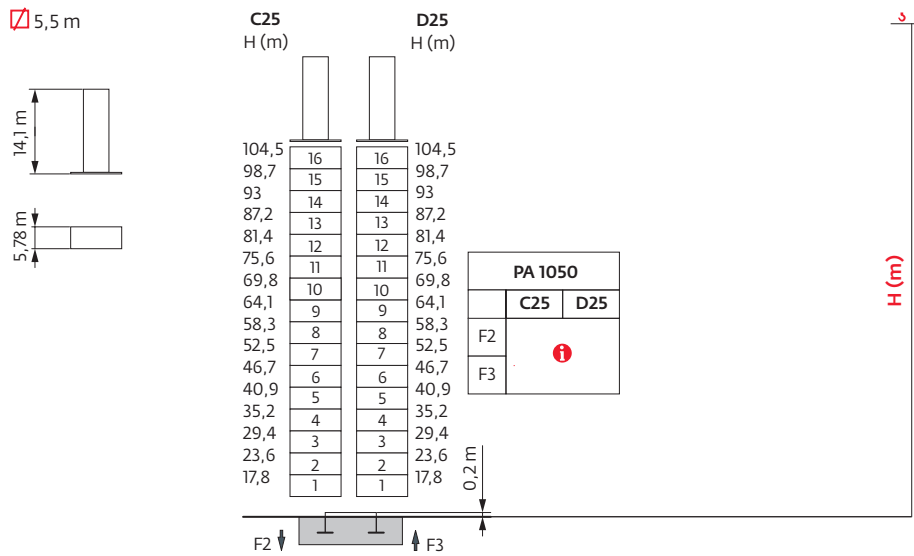

Autres implantations / Aufstellmöglichkeiten / Mounting possibilities / Otras implantaciones / Altre postazioni  
 Outras implantações / Возможности установки

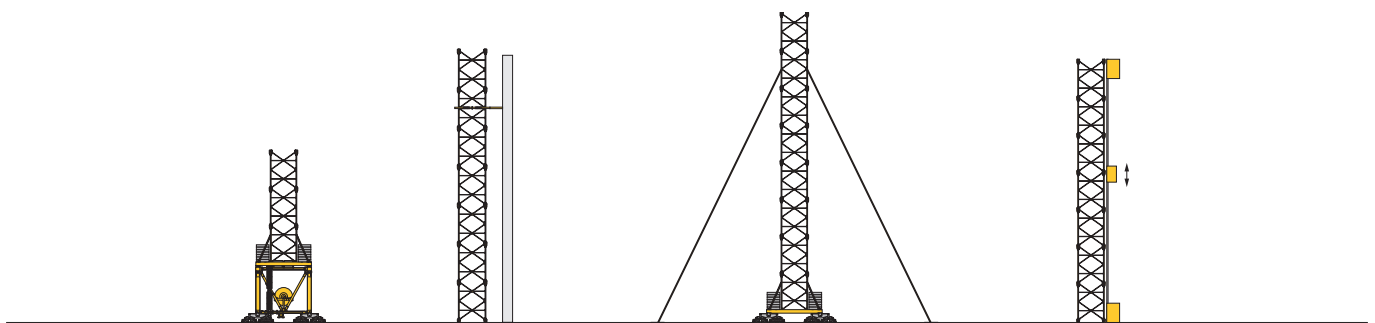

Courbes de charges / Lastkurven / Load curves / Curvas de cargas / Curve di carico  
 Curvas de carga / Кривые нагрузок



80 m/85 m	6,5	▶	36	40	45	50	55	60	63,6	71,3	75	<b>80</b>	<b>85</b>	m
▲▲▲▲			64	56,6	49,2	43,3	38,5	34,5	32	32	30,2	28	26	t
60 m/70 m	6,5	▶	44,1	45	50	55	<b>60</b>	65	<b>70</b>	m				
▲▲▲▲			64	62,6	55,4	49,5	44,6	40,4	36,8	t				
50 m	6,5	▶				<b>50</b>	m							
▲▲▲▲						64	t							

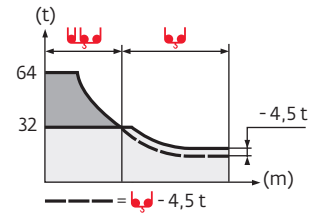

80 m/85 m	5,7	▶	36,3	45	50	55	60	64,3	66,1	70	75	<b>80</b>	<b>85</b>	m
▲▲▲▲			64	49,8	43,9	39	35	32	32	29,8	27,2	25	23	t
60 m/70 m	5,7	▶	44,3	45	50	55	<b>60</b>	65	<b>70</b>	m				
▲▲▲▲			64	62,8	55,6	49,7	44,75	40,6	37	t				
50 m	5,7	▶				<b>50</b>	m							
▲▲▲▲						64	t							

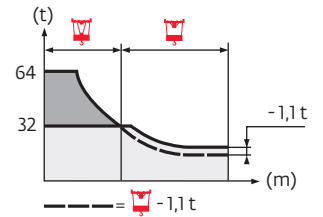

80 t

70 m	6,5	▶	37	40	45	50	55	60	65	<b>70</b>	m
▲▲▲▲			80	73,3	64,1	56,8	50,8	45,8	41,6	37,9	t
70 m	6,5	▶				53,4	55	60	65	<b>70</b>	m
▲▲▲▲						53,3	51,6	46,6	42,3	38,7	t

Mécanismes / Triebwerke / Mechanisms / Mecanismos / Meccanismi  
 Mecanismos / Механизмы

400 V - 50 Hz														ch - PS hp	kW				
	<b>270 LVF 160 Optima</b>	64 t	m/min	31	41	58	93	107	16	20	29	47	54	270	200	641 m			
			t	32	24	16	8	4,9	64	48	32	16	11,6						
	<b>25 DVF 30</b>		m/min	0 → 25 (64 t) 0 → 50 (32 t) 0 → 90 (16 t) 0 → 115 (8 t)													25	18,5	
	<b>RVF 196 Optima+</b>		tr/min U/min rpm	0 → 0,6													6 x 15	6 x 11	

400 V - 50 Hz														ch - PS hp	kW	
	<b>270 LVF 133 Optima</b>	80 t	m/min	18,6	24,3	35,3	50,6	64	12,4	16,2	23,5	33,7	42	270	200	702 m
			t	53,3	40	26,7	17,7	10	80	60	40	27,3	16			
	<b>25 DVF 33</b>		m/min	0 → 50 (80 t)											25	18,5
	<b>RVF 196 Optima +</b>	tr/min	0 → 0,6											6 x 15	6 x 11	

400 V - 50 Hz													ch - PS hp	kW					
			100 t																
			120 t																
			160 t																

	<b>IEC 60204-32</b>	
400 V (+10% -10%) 50 Hz		270 LVF : 289 → 181 kVA

Pour toute demande spécifique merci de nous consulter. / Für jede spezielle Anfrage, bitte bei uns rückfragen.  
 For any special request, please consult us. / Para toda pregunta específica, gracias por consultarnos.  
 Per qualsiasi domanda specifica, vi preghiamo di contattarci. / Queiram por favor contactar-nos para qualquer esclarecimento técnico adicional.  
 В случае нестандартных вопросов, пожалуйста, консультируйтесь с нами.

	FR	DE	EN	ES	IT	PT	RU
	Profil de vent suivant EN 14439 C25-D25	Windbedingungen gemäss EN 14439 C25-D25	Wind conditions according to EN 14439 C25-D25	Conformidad de los condiciones de viento EN 14439 C25-D25	Condizioni del vento secondo EN 14439 C25-D25	Perfil de vento conforme EN 14439 C25-D25	Ветровой режим в соответствии с EN 14439 C25-D25
	Équipements standards	Standardausrüstungen	Standard equipment	Equipamiento de serie	Equipaggiamento standard	Equipamento de série	Стандартное оборудование
	Équipements optionnels	Sonderausrüstungen	Options	Equipamiento opcional	Equipaggiamento in opzione	Equipamento opcional	Дополнительное оборудование (опция)
	Levage	Heben	Hoisting	Elevación	Sollevamento	Elevação	Подъем
	Distribution	Katzfahren	Trolleying	Distribución	Distribuzione	Distribuição	Перемещение по стреле
	Orientation	Schwenken	Slewing	Orientación	Rotazione	Rotação	Поворот
	Translation	Kranfahren	Travelling	Traslación	Traslazione	Translação	Перемещение крана
	Puissance requise	Erforderliche Leistung	Required power	Potencia Necesaria	Potenza richiesta	Potência Necessária	Потребляемая мощность
	Fonction Power Control : vitesses treuils adaptées à la puissance disponible	Funktion Power Control: Geschwindigkeiten der Triebwerke werden an die verfügbare Leistung angepasst	Power Control Function: winch speeds adapted to the available power	Función Power Control: marchas de los cabrestantes adaptadas a la potencia disponible	Funzione Power Control: velocità degli argani adattate alla potenza disponibile	Função Power Control: velocidades de guincho adaptadas à potência disponível	Функция контроля мощности Power Control: регулировка скорости лебедок в зависимости от доступной мощности
	Nous consulter	Auf Anfrage	Consult us	Consultarnos	Consultateci	Consultar-nos	Проконсультируйтесь у нас
	Document commercial non contractuel. Pour toute information technique se référer à la notice correspondante.	Unverbindliches Vertriebsdokument. Für technische Informationen, siehe die entsprechenden Anweisungen.	This commercial document is not legally binding. For any technical information, please refer to the corresponding instructions.	Documento comercial no contractual. Para cualquier información técnica, ver la noticia correspondiente.	Documento commerciale non vincolante, per tutte le informazioni tecniche fare riferimento al catalogo istruzioni.	Documento comercial não contratual. Para qualquer informação técnica complementar consultar as respectivas instruções.	Этот коммерческий документ не является юридически обязательным. Для получения технической информации, см. соответствующие инструкции.

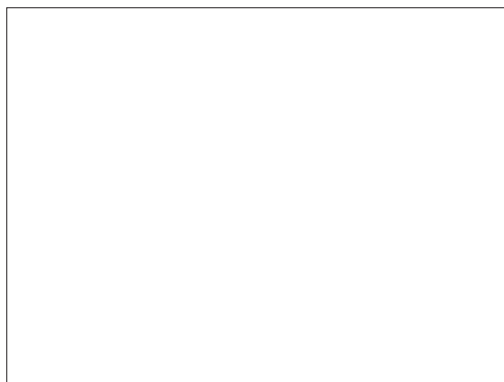

<p><b>Americas</b>  <b>Manitowoc, Wisconsin, USA</b>                  Tel: +1 920 684 6621                  Fax: +1 920 683 6277</p> <p><b>Shady Grove, Pennsylvania, USA</b>                  Tel: +1 717 597 8121                  Fax: +1 717 597 4062</p>	<p><b>Europe, Middle East, Africa</b>  <b>Dardilly, France</b>                  Tel: +33 (0)4 72 18 20 20                  Fax: +33 (0)4 72 18 20 00</p> <p><b>China</b>  <b>Shanghai, China</b>                  Tel: +86 21 6457 0066                  Fax: +86 21 6457 4955</p>	<p><b>Greater Asia-Pacific</b>  <b>Singapore</b>                  Tel: +65 6264 1188                  Fax: +65 6862 4040</p>
---	--	--